

A DESIGN METHOD FOR LOGICAL TOPOLOGIES WITH CONSIDERATION OF WAVEBANDS

Yukinobu Fukushima

*Department of Informatics and Mathematical Science
Graduate School of Engineering Science, Osaka University
1-3 Machikaneyama, Toyonaka, Osaka 560-8531, Japan
y-fukusm@ics.es.osaka-u.ac.jp*

Shin'ichi Arakawa

*Graduate School of Economics, Osaka University
1-7, Machikaneyama, Toyonaka, Osaka 560-0043, Japan
arakawa@ics.es.osaka-u.ac.jp*

Masayuki Murata

*Cybermedia Center, Osaka University
1-30, Machikaneyama, Toyonaka, Osaka 560-0043, Japan
murata@cmc.osaka-u.ac.jp*

Hideo Miyahara

*Department of Informatics and Mathematical Science
Graduate School of Engineering Science, Osaka University
1-3 Machikaneyama, Toyonaka, Osaka 560-8531, Japan
miyahara@ics.es.osaka-u.ac.jp*

Abstract

Among the several architectures for IP (Internet Protocol) over WDM networks, one promising approach is to overlay a logical topology that consists of lightpaths on the physical WDM network, such that each lightpath carries IP traffic between edge nodes. Many of the conventional methods for designing the logical topology deal with the case of a constant number of wavelengths being available on each fiber. While the number of wavelengths offered by current optical technology is now of the order of thousands, it is not necessary to utilize all wavelengths on each fiber in building an effective logical topology on a WDM network. Instead, several wavebands may be considered for introduction by deploying optical fiber amplifiers when additional wavelengths are actually required. In this case, the number of available wavelengths on the respective fibers depends on the number of optical fiber amplifiers deployed on each fiber. In this paper, we propose a new heuristic algorithm for the design of a logical topology with as few optical fiber amplifiers as possible, so that the approach is cost-effective. We then compare our proposal with conventional methods in terms of average packet delays and throughput, and show that our algorithm reduces the number of optical fiber amplifiers required. We also investigate the effect of increasing the number of wavelengths multiplexed on each fiber, by assuming that the product

of the number of available wavelengths and the bandwidth of each wavelength is constant. The results show that such a logical topology is able to accommodate a greater volume of traffic by multiplexing more wavelengths on each fiber. The approach thus conforms to *Cao's Law*.

Keywords: IP over WDM, Wavelength Division Multiplexing, logical topology, fiber amplifier

1. INTRODUCTION

WDM (wavelength-division multiplexing) technology, in which multiplexed wavelength channels are carried on a single fiber, is expected to provide the infrastructure of the next generation Internet. Since the majority of Internet traffic is 'packets' on IP (Internet Protocol), much recent research has been devoted to an IP over WDM network where IP packets are directly carried over the WDM network. Among several architectures for IP over WDM networks, one promising approach is to create a logical topology that is made up of lightpaths as an overlay upon the physical WDM network, each of which carries IP traffic between edge nodes [1]. Such a lightpath is a wavelength-channel that does not require any electronic processing at intermediate nodes. This reduces the load of packet processing at IP routers.

The number of wavelengths available on a single fiber is an important parameter in the design of the logical topology. Having more wavelengths multiplexed on each fiber allows the network to accommodate more lightpaths. Using a spectral range of 1290–1690 nm is considered about 1,000 wavelengths on the fiber. As has been discussed in earlier work [2, 3], deploying additional optical fiber amplifiers makes high loss regions (e.g., 1530 nm - 1610 nm) available. That is, we will require several kinds of optical fiber amplifiers to utilize 1,000 wavelengths. Figure 1 [2] shows the amplifiers required across the spectral to realize 1,000 wavelengths. Since preparing several amplifiers for the entire spectral range is costly, we want to reduce the number of optical amplifiers (and the number of wavelengths) on the fiber. We can actually realize this because 1,000 wavelengths are not necessary at all links. For this purpose, however, we need a new way of designing the logical topology such that it minimizes the number of optical amplifiers while meeting the demands imposed by traffic. This is the main subject of our current paper. A lot of work has dealt with methods for the design of the logical topology [4]. For example, one approach is to minimize the number of wavelengths required within the WDM network [5, 6]. Much other work has been based on the assumption that a constant number of wavelengths is available on each fiber [7, 8]. However, the number of multiplexed wavelengths is determined by the number of the wave-bands available, thus the number of the optical fiber amplifiers deployed on the fiber. Therefore, in a cost-effective design of the logical topology, we need to introduce fiber amplifiers only on fiber which would otherwise lack the required bandwidth (i.e., number of wavelengths). Many existing design algorithms are only intended for use with a rather small number of wavelengths. Thus, the resulting optimization problem is to try to completely utilize the wavelengths on the fiber in accommodating the traffic. In this paper, we propose a new algorithm called MALDA (Minimum number of fiber Amplifiers Logical topology Design Algorithm). This algorithm is in contrast to earlier approaches in that it minimizes the deployment of optical fiber amplifiers on the fiber, rather than minimizing the number of wavelengths required to accommodate the traffic demand.

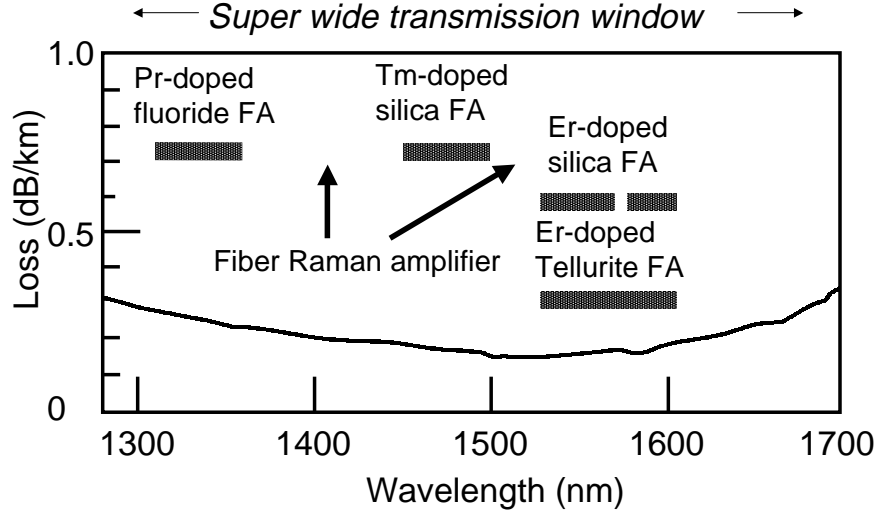

Figure 1 Loss Spectrum of Typical Low-Loss Optical Fiber

We also investigate the effect of increasing the number of wavelengths which are multiplexed on the fiber, by assuming that the product of the number of available wavelengths and the bandwidth of each wavelength is constant. The results will show that the logical topology is able to accommodate a greater volume of traffic by making it possible to multiplex a greater number of wavelengths on the fiber, which conforms to *Cao's Law* [9].

The paper is organized as follows. In Section 2, we extend the conventional method for designing the logical topology to set lightpaths based on the actual traffic demand. We next propose a logical topology design method that has, as its objective function, the minimization of the number of fiber amplifiers. This is in Section 3. Section 4 is a comparative evaluation of our proposed algorithms and the conventional algorithm. We finally conclude our paper in Section 5.

2. DESIGN OF LOGICAL TOPOLOGY BASED ON A REQUESTED TRAFFIC VOLUME

In this section, we extend MLDA (Minimum-delay Logical topology Design Algorithm), a conventional method for designing the logical topology proposed in [10]. Since MLDA only targets the network with a small number of wavelengths multiplexed, the logical topology designed by MLDA may not accommodate the traffic demand when a large number of wavelengths are multiplexed in the network. On the other hand, we want to accommodate the given traffic demand, the unit of which has a particular value in, e.g., Gbps, on the network with a lot of wavelengths multiplexed. Then, our new algorithm set lightpaths enough to accommodate the volume of required traffic. We call our new algorithm the e-MLDA (extended MLDA). We need this extension to deal with our main objective of minimizing the number of optical fiber amplifiers. This objective is covered in the next section. Throughout this paper, we assume that there is no wavelength conversion at the nodes. Note that in this section we extend the conventional approach assuming that the number of wavelengths on the fiber is fixed. In the next section, we will cover the case where the number of wavelengths is a design variable that is dependent on some number of costly optical amplifiers.

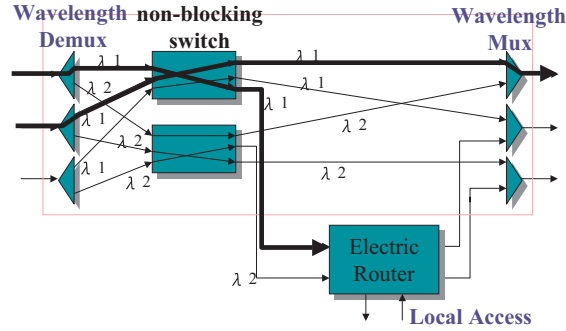

(a) Node Architecture

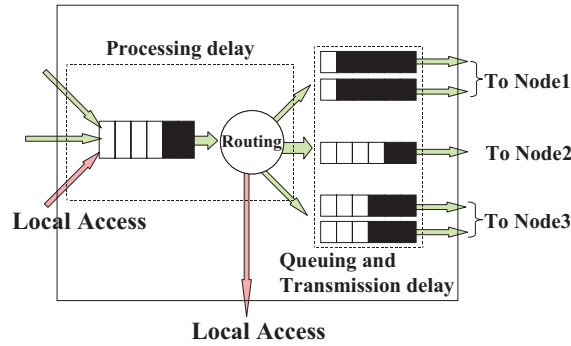

(b) Model of Electronic Router

Figure 2 Node Architecture Model

Before describing our algorithm, we depict the node-architecture model in Figure 2 [8]. Every node in the physical topology is equipped with an optical switch and an electronic router. The optical switch consists of three main blocks; input section, a non-blocking switch, and output section. In the input section, the optical signals are demultiplexed into W fixed wavelengths, $\lambda_1, \dots, \lambda_W$. Each wavelength is then switched into an appropriate output port, without wavelength conversion, by a non-blocking switch. Finally, the wavelengths are again multiplexed on the fiber, that go to the respective next nodes. Note that a lightpath is configured by the non-blocking switches along the paths, so that the traffic on a particular wavelength is forwarded from the input port to the required output port without any electronic processing.

At the terminal node of a lightpath, IP packets in the lightpath are converted to electronic signals and forwarded to the electronic router. The electronic router processes the packet forwarding, in the same way as in a conventional router. If the packet requires further forwarding to other nodes, it is put on the appropriate lightpath. IP packets, whether they come through the optical switch or are received via local access, are first buffered for processing. The packets are then processed on a FIFO (first-in first-out) basis. Packets that are to be forwarded within the network are queued in the appropriate output port buffer.

We introduce the following notations to represent the physical network.

N : The number of nodes in the WDM network.

P_{ij} : Represents the elements of the physical topology. If there is a fiber that connects node i and node j , then $P_{ij} = 1$, otherwise $P_{ij} = 0$.

Q : A traffic distribution matrix. The value of an element (i, j) represents the traffic demand between nodes i and j .

C : Bandwidth of each wavelength.

W : The number of wavelengths multiplexed on a single fiber.

Given these parameters, the e-MLDA designs the logical topology by setting up multi-hop lightpaths which are sufficient to accommodate the requested traffic volume between nodes. Our e-MLDA sets the lightpaths on the shortest routes in terms of the propagation delay between nodes. The wavelength chosen for the lightpaths is based on a First-Fit policy, that is, the e-MLDA selects the wavelength with the lowest index of λ among those wavelengths not yet assigned to lightpaths. Note that the wavelengths that are not used are left in our algorithm while MLDA uses all the wavelengths on each fiber.

We use the following notation to explain our algorithm.

t, v : Originating/terminating nodes of a lightpath.

q_{ij} : Traffic volume that is requested for node-pair (i, j) .

B_{ij} : A node connected to node j along the shortest path from node i to node j .

T_{ij} : The total available bandwidth in existing lightpaths between nodes i and j .

Using this notation, we now explain our e-MLDA algorithm. This is followed by some additional comments on the algorithm.

Step 1 Select a pair of nodes (i', j') such that element $q_{i'j'}$ of the traffic-distribution matrix Q is the largest. We start by selecting a node pair which is directly connected by fiber. If $q_{i'j'} = 0$, then the lightpaths are prepared between all the nodes. Thus, we can terminate our algorithm in finite steps. Otherwise, go to Step 2.

Step 2 Initialize the variables as $t \leftarrow i', v \leftarrow j'$. Then, go to Step 3 and try to set lightpaths of adequate capacity between nodes t and v .

Step 3 If $t = j'$, the lightpaths have enough capacity to accommodate the traffic from node i' to node j' . Then, set $q_{i'j'} \leftarrow 0$, and go back to Step 1. Otherwise, go to Step 4.

Step 4 Try to accommodate $q_{i'j'}$ on the existing lightpaths between nodes t and v according to the following two conditions.

- 1 If $T_{tv} > q_{i'j'}$, then we can accommodate $q_{i'j'}$ by using the existing lightpaths between nodes t and v . That is, set $t \leftarrow v, v \leftarrow j'$ and go back to Step 3.
- 2 If $T_{tv} \leq q_{i'j'}$, on the other hand, it is not possible to accommodate $q_{i'j'}$ on the existing lightpaths. Thus, go to Step 5 and try to set new lightpaths between nodes t and v .

Step 5 Try to set $\lfloor (q_{i'j'} - T_{tv})/C \rfloor$ lightpaths between nodes t and v . If it is possible to set the lightpaths, go to Step 5.1. Otherwise, go to Step 5.2.

Step 5.1 After setting up the lightpaths between nodes t and v , we cut the lightpath at node v if another lightpath passes through nodes t and v . Then, we set $t \leftarrow v$, $v \leftarrow j'$ and go back to Step 3.

Step 5.2 If nodes t and v are directly connected via fiber, we are unable to set up lightpaths between nodes t and v . In this case, it is not possible to accommodate the requested traffic between nodes i' and j' , and we terminate our algorithm. If nodes t and v are not directly connected, on the other hand, we try to accommodate the traffic by creating lightpaths between node t and inter-node v . Set $v \leftarrow B_{tv}$ and go back to Step 4.

Comments on e-MLDA

In Step 1, e-MLDA selects a node-pair (i', j') in descending order of traffic volume. To ensure that traffics are able to reach any nodes, we start by setting up lightpaths between the pairs of neighboring nodes. Step 4 checks whether or not existing lightpaths are capable of accommodating the traffic $q_{i'j'}$. If the available bandwidth T_{tv} is insufficient to transport the IP traffic, new lightpaths are set up in Step 5. Since T_{tv} is already available by existing lightpaths, the number of lightpaths required to accommodate the requested traffic volume is $\lfloor (q_{i'j'} - T_{tv})/C \rfloor$.

Step 5.1 deals with the case where we are able to set up enough lightpaths to accommodate the requested traffic. However, in IP over WDM network, we must consider the property of the IP, that is, only the shortest path is utilized by IP traffic, even if lightpaths with longer delays are available. To avoid having different delays for lightpaths, we alter any lightpath that originates at node t and passes through the node v so that it terminates at node v . In Step 5.2, if we are unable to set up the required lightpaths because too few wavelengths are available, we set $v \leftarrow B_{tv}$ and go back to Step 4 in order to accommodate q_{ij} between nodes t and B_{tv} . Note that, after $q_{i'j'}$ has been accommodated between t and B_{tv} , Step 5.1 sets t to B_{tv} and v to j' . We then try to set up a lightpath between nodes B_{tv} and j' .

3. DESIGNING THE LOGICAL TOPOLOGY WITH CONSIDERATION OF THE AVAILABLE WAVE-BANDS

In this section, we propose a new method for designing the logical topology with the minimum number of optical fiber amplifiers. Our method is based on the e-MLDA, as presented in the previous section.

3.1. OBJECTIVE FUNCTION

The methods conventionally used to design the logical topology, including our e-MLDA, are based on the assumption that a fixed number of wavelengths is available on each fiber. However, the number of available wavelengths on a fiber depends on the number of optical fiber amplifiers prepared on the fiber. In this section, we propose a new method for the design of logical topologies. The method has the aim of minimizing the number of optical fiber amplifiers within the WDM network, rather than the number of wavelengths required. We call this algorithm the MALDA (minimum number of fiber amplifiers logical topology design algorithm).

In our MALDA, W_1 ($< W$) wavelengths are initially set for carriage by each fiber. When there is no available wavelength on a certain fiber during the subsequent design of the logical topology, W_i wavelengths are added by introducing an additional fiber amplifier i ($2 \leq i \leq N_{max}$). Here, we assume that N_{max} kinds of fiber amplifiers may be deployed on the fiber. If the maximum number of possible wavelengths on a fiber is W , we obtain the following relationship for fiber f .

$$\sum_{i=1}^{N_f} W_i \leq W \quad (1)$$

where N_f ($1 \leq N_f \leq N_{max}$) is the number of fiber amplifiers deployed on fiber f . The objective function of MALDA is,

$$\text{minimize} \quad \sum_{f \in F} N_f \quad (2)$$

On the other hand, the e-MLDA designs the logical topology with N_{max} fiber amplifiers deployed on each fiber.

3.2. DETAILED DESCRIPTION OF MALDA

In MALDA, fiber amplifiers are added to fiber when too few wavelengths are available to set up new lightpaths that are required. The algorithm terminates when the traffic demand has been accommodated. Accordingly, we expect that the smallest possible number of fiber amplifiers will then be deployed in the WDM network. MALDA is similar to e-MLDA described in Section 2. The point of difference between e-MLDA and MALDA is that the latter only deploys an additional fiber amplifier when the wavelengths are too few to accommodate the traffic. For this purpose, we need to modify Step 5.2 of e-MLDA. Once a fiber amplifier has been added to a fiber, we are able to connect a lightpath that uses the newly available wavelengths. Whether or not a new amplifier should or may be added is checked in the new step, Step 6. The following two steps are the only difference between the e-MLDA and the MALDA.

Step 5.2 If nodes t and v are directly connected via a fiber, we may be able to set up lightpaths between nodes t and v . In this case, we try to accommodate $q_{i'j'}$ by deploying a new fiber amplifier on the fiber, so we go to Step 6. If nodes t and v are not directly connected, on the other hand, then we set $v \leftarrow B_{tv}$ and go back to Step 4.

Step 6 Check the number of fiber amplifiers currently deployed on the fiber between nodes t and v . If N_{max} amplifiers have already been used, it is not possible to accommodate the required traffic and we terminate our algorithm. Otherwise, we add an additional fiber amplifier to increase the number of available wavelengths on the fiber, and connect the existing lightpaths (see the next subsection for more detail). We then set $v \leftarrow j'$ and go back to Step 4 in order to check whether or not we are able to set up new lightpaths between nodes t and v by adding a fiber amplifier.

In the next subsection, we will explain the algorithm used to connect lightpaths.

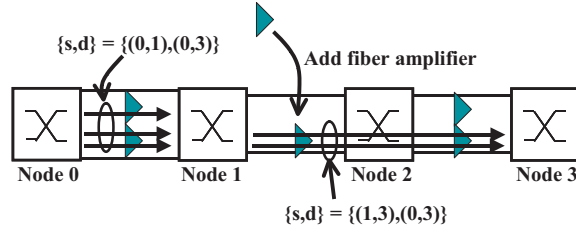

(a) before connecting lightpaths

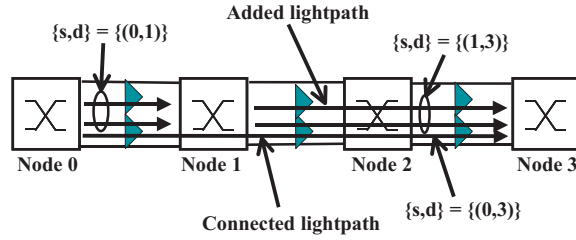

(b) after connecting lightpaths

Figure 3 sample of connecting lightpaths

3.3. CONNECTING LIGHTPATHS

In this subsection, we introduce the algorithm that connects lightpaths between two nodes after a new fiber amplifier has been added. We can expect this to decrease the load on the IP routers at those nodes. We connect lightpaths at the node selected in descending order of the traffic load on the two nodes.

Let us define x as the node at which we are trying to connect lightpaths. We also define any two nodes, to fiber between which a new fiber amplifier is deployed, as i and j . We try to connect LP_{ix} and LP_{xj} . We only connect lightpaths in the case where (1) there are enough available wavelengths to connect the lightpaths and (2) we are able to accommodate traffic that overflows from the connected lightpaths by placing it on other lightpaths (see below for an example).

For case (1), we select the set of node-pair $\{s, d\}$ and the traffic transmitted via both LP_{ix} and LP_{xj} . We next check whether enough wavelengths are available to connect lightpaths which accommodate $\sum_{ab \in \{s, d\}} q_{ab}$. For case (2), we check whether we are able to accommodate that traffic transmitted via LP_{ix} which overflows from the connected lightpaths, and that transmitted via LP_{xj} which overflows from the connected lightpaths. If the tests for both case (1) and case (2) are satisfied, we connect the number $\lfloor \sum_{ab \in \{s, d\}} q_{ab} / C \rfloor$ of LP_{ix} and LP_{xj} .

Figure 3 shows a simple example of the connection of lightpaths. Suppose that the newly added fiber amplifier makes two wavelengths available. Suppose that $C = 10$ Gbps, and the traffic demands on node pairs $\{0, 1\}$, $\{0, 3\}$, and $\{1, 3\}$ are 15, 7, and 12 Gbps, respectively. The traffic of node pair $\{0, 3\}$ is transmitted via LP_{01} and LP_{13} since the lack of wavelengths means that it is not possible to create LP_{03} (see Figure 3(a)). After the fiber amplifier has been added to the fiber between nodes 1 and 2, we try to connect lightpaths at node 1 and node 2.

Firstly, we try to connect LP_{01} and LP_{13} at node 1. Now We are only trying to connect one lightpath since the traffic for node pair $\{0, 3\}$ is 7 Gbps. We then check whether or not it is possible to accommodate traffic that overflows on other lightpaths. After connecting the lightpaths, there are two paths LP_{01} and one path LP_{13} . The existing LP_{13} is unable to accommodate the traffic of node pair $\{1, 3\}$, and we must check whether or not it is possible to accommodate $\{1, 3\}$ by setting up a new path LP_{13} . Since this is possible in the current case, we set up the new LP_{13} and connect one path LP_{01} and LP_{13} (see Figure 3(b)).

We next consider adding an optical fiber amplifier to decrease the traffic load on the IP router. By connecting lightpaths until the load on the IP router fails below the processing capacity of the IP router, we accommodate more traffic. For safer operation, we might limit the maximum amount of traffic accommodated at the IP router to, e.g., 90% of its processing capability. To explain this, we introduce the following notations.

- N_{high} : The set of nodes at which the traffic load on the IP router is beyond its processing capacity.
- $N_{available}$: The set of nodes that have non-utilized wavelength(s) on the fibers that the node is connected to.
- N_{heavy} : The node that has the heaviest traffic load among the set of nodes, chosen from $N_{high} \cap N_{available}$.

We perform the following steps after setting up the lightpaths according to MALDA.

- Step A: Set $N_p \leftarrow N_{high} \cap N_{available}$. If N_p is an empty set, then go to Step C. Otherwise, go to Step B.
- Step B: Randomly choose one fiber from the fibers that are connected to N_{heavy} . Add an optical fiber amplifier to this fiber. Then, try to connect lightpaths through this fiber (see the connecting lightpaths above), and go back to Step A.
- Step C: If some nodes have a traffic load that is above the limit of its processing capacity, then the requested traffic cannot be accommodated, and the algorithm is terminated. Otherwise, the new logical topology has successfully accommodated the traffic and the algorithm is terminated.

The above three steps decrease the loads on overloaded IP routers by connecting lightpaths and bypassing IP routers. If too few wavelengths are available to reduce the load, we deploy additional optical fiber amplifiers. If a node remains in the N_{high} condition even after all possible optical fiber amplifiers have been deployed, we are unable to accommodate the requested traffic.

4. NUMERICAL EXAMPLES

In the previous section, we proposed a method for the design of the logical topology that has objective function of minimizing number of fiber amplifiers. This section is devoted to a comparative evaluation of our MALDA logical topology algorithm, MLDA, and e-MLDA. We introduce the following notation to represent the logical topologies designed by each algorithm.

- LT_{MLDA} : A logical topology designed by MLDA

LT_{e-MLDA} : A logical topology designed by e-MLDA

LT_{MALDA} : A logical topology designed by MALDA

4.1. NETWORK MODEL

In this evaluation, we use NTT's 49-node backbone network in Japan as the network model and two different traffic patterns, P_1 and P_2 . P_1 is the publicly available data provided by NTT [11] that is the traffic matrix for conventional telephone calls. The traffic pattern P_2 is randomly determined. The value of each element in P_2 is uniformly distributed between 0 Mbps and 1 Mbps. Since the total traffic loads are small (around 3 Gbps in P_1 and 1.2 Gbps in P_2), we introduce a scale-up factor α . We set the actual requested traffic as α times the elements of P_1 and P_2 . The bandwidth of each wavelength is set to 10 Gbps, and up to 1,000 wavelengths may be multiplexed on a single fiber. The processing capacities of the electronic routers (Figure 2(b)), expressed as μ , are set at 640 Gbps, 5.6 Tbps [12] and 16 Tbps.

4.2. EVALUATION METRICS

We evaluate the respective logical topology by deriving the average delay, throughput, and number of fiber amplifiers obtained by the corresponding algorithms. The average delay is defined as follows.

$$\bar{T} = \frac{1}{N(N-1)} \sum_{s=1}^N \sum_{d=1}^N D_{sd} \quad (3)$$

where N is the number of nodes in the network and D_{sd} is the delay on traffic between nodes s and d . In our architectural model shown in Figure 2(b), the delay experienced at a node consists of the processing delay and the transmission delay. Thus, D_{sd} is represented as

$$D_{sd} = \sum_{i=1}^N a_i^{sd} \cdot QD_i + \sum_{i=1}^N \sum_{j=1}^N b_{ij}^{sd} \cdot TD_{ij} + \sum_{i=1}^N \sum_{j=1}^N b_{ij}^{sd} \cdot PD_{sd}. \quad (4)$$

The notation used in Eq. (4) is as follows.

QD_i : The delay for processing at the IP router on node i . We determine this by using an M/M/1 queueing model.

TD_{ij} : The transmission delay experienced in the buffer of the lightpath between node i and node j . If there are several lightpaths, the IP traffic is divided into flows such that the rate of transmission is identical on each of the lightpath. The delay at the buffer is also calculated by using an M/M/1 queueing model.

PD_{sd} : The propagation delay of lightpaths between end nodes s and d .

a_i^{sd} : If the IP router on node i processes the traffic from node s to node d , then $a_i^{sd} = 1$. Otherwise $a_i^{sd} = 0$.

b_{ij}^{sd} : If the traffic from node s to node d goes through the lightpath between node i and node j , then $b_{ij}^{sd} = 1$. Otherwise $b_{ij}^{sd} = 0$.

4.3. NUMERICAL DISCUSSIONS

Figures 4, 5, and 6 show the dependence of average delay on the total requested traffic for the traffic matrix P_1 . Each figure depicts the case for IP routers with one of the three capacities. Figures 7, 8, and 9 are for P_2 . For the MLDA, we assume that 1,000 wavelengths are always used. For the e-MLDA and MALDA, we set the utilization rate of each lightpath to be under 70%. If the rate of utilization of a lightpath is greater than that value, we set up new lightpaths. In the case of the e-MLDA, the logical topology is built on the assumption that 1,000 wavelengths are available. To obtain the figures, however, we have simply removed the unnecessary optical amplifiers after the logical topology has been built for fair comparison with MALDA. In MALDA, the number of amplifiers on each fiber is determined by the algorithm presented in Section 3. For this, we have assumed that $W_1 = 200$, $W_i = 100$ and $N_{max} = 9$.

From these figures, we can see that the average delays on LT_{e-MLDA} and LT_{MALDA} decrease even when the requested traffic volume increases. This is because both of those logical topologies change according to the requested traffic volume. In Figures 4 through 9, the delay on LT_{MALDA} is always larger than that on LT_{e-MLDA} . This is because the MALDA tries to accommodate traffic by using existing lightpaths, whereas the e-MLDA sets up new lightpaths since the e-MLDA is able to utilize more wavelengths than the MALDA is on each fiber. This results in a higher rate of utilization of lightpaths by LT_{MALDA} than by LT_{e-MLDA} .

We next discuss the throughput of each of the logical topologies. Here, the throughput is defined as the minimum requested traffic volume (more precisely, the scale-up factor α) such that the average delay reaches saturation. In Figures 4 ($\mu = 640$ Gbps), 5 ($\mu = 5.6$ Tbps) and 7 ($\mu = 640$ Gbps), LT_{MALDA} accommodates as much traffic as LT_{e-MLDA} . This is because the bottleneck for the network in these cases is the processing capacity of the IP router. However, LT_{MALDA} shows a higher throughput than LT_{e-MLDA} in Figures 6 ($\mu = 16$ Tbps), 8 ($\mu = 5.6$ Tbps) and 9 ($\mu = 16$ Tbps). In these cases, the large capacity of the respective IP routers means that the bottleneck for the network is not this capacity but the link capacity. Overall, MALDA more effectively utilizes the bandwidth of the lightpaths than does e-MLDA.

Required number of optical fiber amplifiers are shown in Figures 10, 11, and 12 for P_1 , and 13, 14, and 15 for P_2 . Note that, in figure 13, the number of optical fiber amplifiers required in LT_{MALDA} is uneven when total traffic volume is about 10 Tbps. This is because the MALDA deployed too much fiber amplifiers when it tried to decrease the load on overloaded IP routers. We see that LT_{MALDA} requires for fewer optical fiber amplifiers than does LT_{e-MLDA} .

4.3.1 Does Cao's Law apply to our case?. We next investigate the effect of increasing the number of wavelengths that are multiplexed on the fiber. The fiber bandwidth is defined as the product of W and C , i.e., of the number of wavelengths multiplexed on the fiber and the bandwidth of the wavelengths. Cao's Law [9] states that it is better to increase W larger since increasing C has a non-linear effect that decreases the efficiency of traffic transportation on the fiber.

We examine the effect of increasing W while keeping the product of W and C constant, i.e., the case where the total fiber bandwidth is limited by the properties of the fiber. We use e-MLDA. Figures 16, 17, and 18 plots of dependence of the maximum allowable traffic volume on the number of wavelengths multiplexed on the fiber for the traffic pattern P_1 . The throughput in Figure 16 is constant.

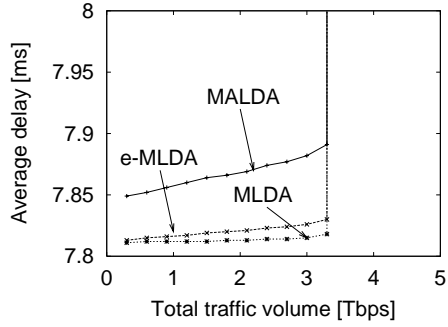

Figure 4 The average delay with traffic pattern P_1 : $\mu = 640$ Gbps

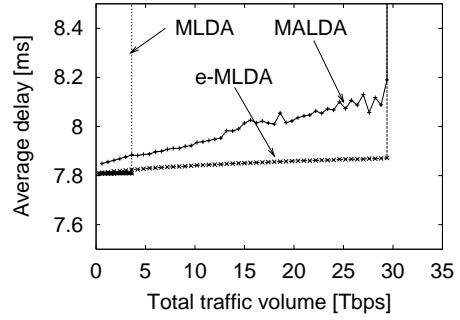

Figure 5 The average delay with traffic pattern P_1 : $\mu = 5.6$ Tbps

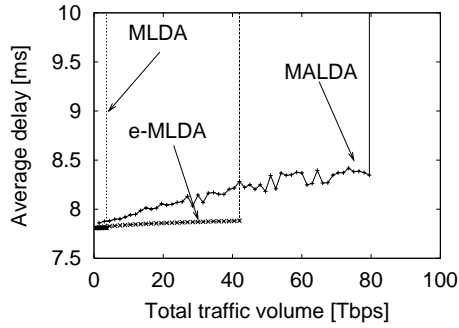

Figure 6 The average delay with traffic pattern P_1 : $\mu = 16$ Tbps

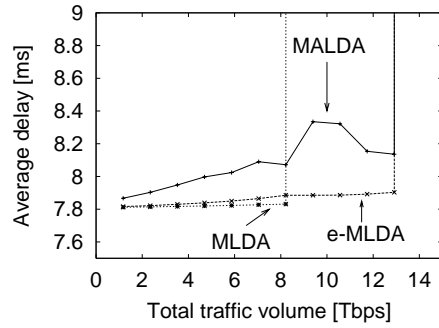

Figure 7 The average delay with traffic pattern P_2 : $\mu = 640$ Gbps

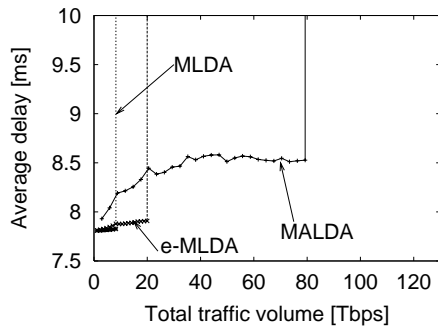

Figure 8 The average delay with traffic pattern P_2 : $\mu = 5.6$ Tbps

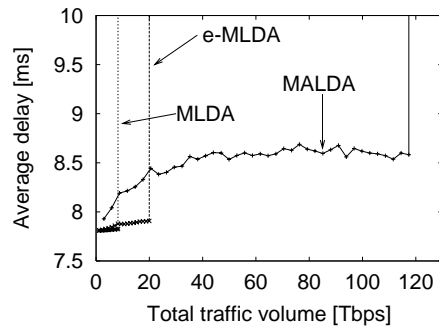

Figure 9 The average delay with traffic pattern P_2 : $\mu = 16$ Tbps

The reason for this is as follows. In this case, the load on the nodes reaches the processing capacity of the IP routers. Each node then tends to devote its limited processing capacity to handling traffic flows that originate and terminating at that node and to avoid traffic that is in transit. In this situation, it is not possible to decrease the load on a node by multiplexing more wavelengths on the fiber.

For $\mu = 5.6$ Tbps (Figure 17) and $\mu = 16$ Tbps (Figure 18), the throughput is limited by the fiber bandwidth rather than by the processing capacity on the

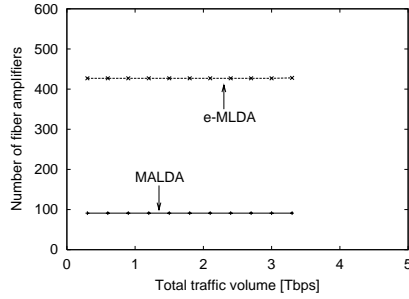

Figure 10 The number of optical fiber amplifiers in a network with traffic pattern P_1 : $\mu = 640$ Gbps

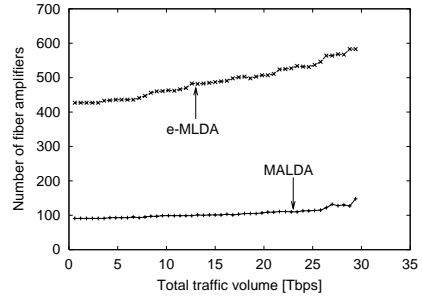

Figure 11 The number of optical fiber amplifiers in a network with traffic pattern P_1 : $\mu = 5.6$ Tbps

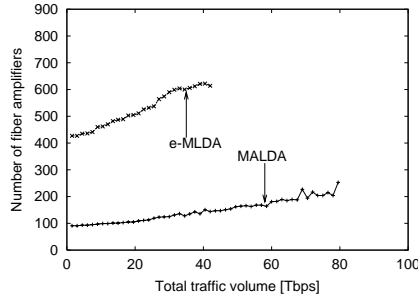

Figure 12 The number of optical fiber amplifiers in a network with traffic pattern P_1 : $\mu = 16$ Tbps

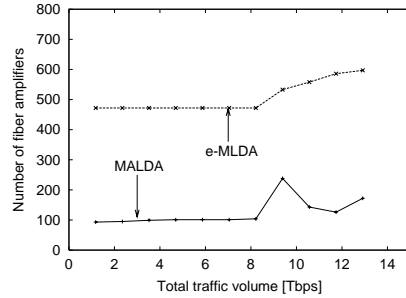

Figure 13 The number of optical fiber amplifiers in a network with traffic pattern P_2 : $\mu = 640$ Gbps

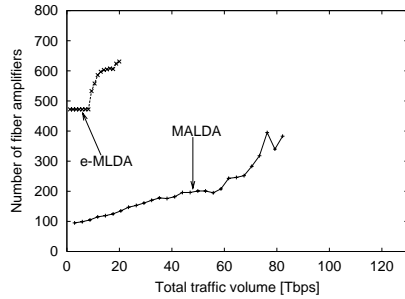

Figure 14 The number of optical fiber amplifiers in a network with traffic pattern P_2 : $\mu = 5.6$ Tbps

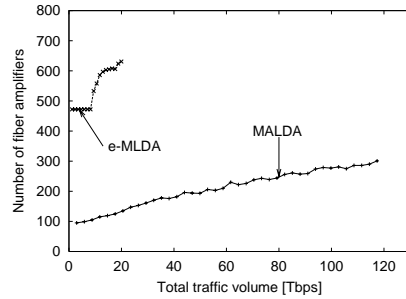

Figure 15 The number of fiber optical amplifiers in a network with traffic pattern P_2 : $\mu = 16$ Tbps

IP router. The larger the bandwidth of each wavelength, the greater the abundant bandwidth that is given to each end-node so that multiplexing fewer wavelengths results in a lower throughput. Thus, the throughput increases as more wavelengths are multiplexed on the fiber.

5. CONCLUSION

In this paper, we have proposed the e-MLDA, a new heuristic algorithm for the design of logical topologies to be overlaid on WDM networks. The resulting topol-

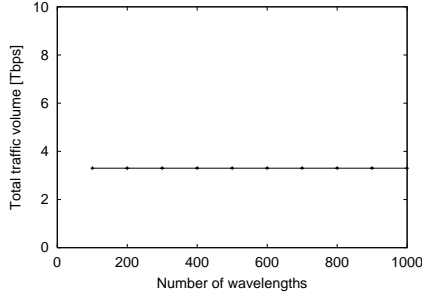

Figure 16 Traffic volume accommodated by NTT network ($\mu = 640$ Gbps).

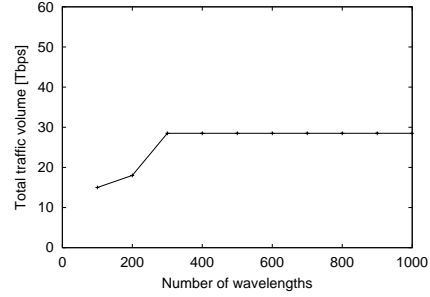

Figure 17 Traffic volume accommodated by NTT network ($\mu = 5.6$ Tbps).

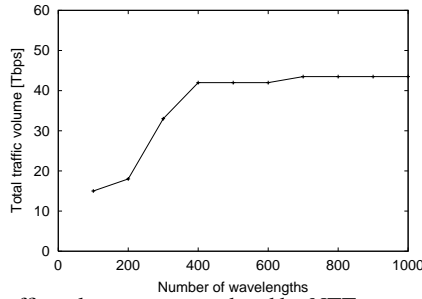

Figure 18 Traffic volume accommodated by NTT network ($\mu = 16$ Tbps).

ogy is based on the actual levels of node-to-node traffic demand. We went on to propose the MALDA, the objective function of which is to minimize the number of fiber amplifiers deployed in the logical topology. Our algorithms are evaluated by comparing them with the conventional method in terms of average delay, throughput, and number of optical fiber amplifiers deployed in the network. The results have shown that MALDA needs fewer fiber amplifiers than e-MLDA, while MALDA is able to accommodate as high a throughput as e-MLDA. Our results indicate that MALDA is preferable in terms of designing a low-cost logical topology. We have also investigated the effect of increasing the number of wavelengths multiplexed on the fiber in the case where the total bandwidth of the optical fiber is limited by the fiber itself (i.e., the product of the number of wavelengths and the capacity of a single wavelength is constant). The results show that multiplexing more wavelengths leads to a higher throughput, a result of which conforms with *Cao's Law*.

In our research, it is assumed that traffic flow is placed on the path with the lowest propagation delay, which is different from the situation for actual IP routing. We need to consider how IP routing affects the performance of the logical topology as a topic for our future research.

ACKNOWLEDGEMENT

This work was supported in part by TAO (Telecommunications Advancement Organization of Japan).

References

- [1] Masayuki Murata, "Challenges for the next-generation Internet and the role of IP over photonic networks," *IEICE Transaction on Communications*, vol. E83-B, pp. 2153–2165, October 2000.
- [2] Masayuki Murata, Ken'ichi Kitayama, and Hideo Miyahara, "IP over a-thousand-wavelength division multiplexing: Is it useful and possible for resolving the network bottlenecks?," *submitted to Optical Networks Magazine*, November 2000.
- [3] H. Yokota, H. Kanamori, and Y. Ishiguro, "Ultra-low-loss pure-silica-core single-mode fiber and transmission experiment," in *Proceedings of 1986 Optical Fiber Conference (OFC '86)*, p. PD3, 1986.
- [4] R. Dutta and G. N. Rouskas, "A survey of virtual topology design algorithms for wavelength routed optical networks," *Optical Network Magazine*, vol. 1, pp. 73–89, January 2000.
- [5] D. Banerjee and B. Mukherjee, "A practical approach for routing and wavelength assignment in large wavelength-routed optical networks," *IEEE Journal on Selected Areas in Communications*, vol. 14, pp. 903–908, June 1996.
- [6] S. Baroni and P. Bayvel, "Wavelength requirements in arbitrarily connected wavelength-routed optical networks," *IEEE/OSA Journal of Lightwave Technology*, vol. 15, pp. 242–251, February 1997.
- [7] R. Ramaswami and K. N. Sivarajan, "Design of logical topologies for wavelength-routed optical networks," *IEEE Journal on Selected Areas in Communications*, vol. 14, pp. 840–851, June 1996.
- [8] Junichi Katou, Shin'ichi Arakawa, and Masayuki Murata, "A design method of logical topology for IP over WDM networks with stable routing," in *Proceedings of ONDM2001*, February 2001.
- [9] George Gilder, Richard Vigilante, and Charles Burger, "Cao's Law," *Gilder Technology Report*, vol. V, no. 10, 2000.
- [10] R. Ramaswami and K. N. Sivarajan, "Design of logical topologies for wavelength-routed all-optical networks," in *Proceedings of IEEE INFOCOM*, pp. 1316–1325, April 1995.
- [11] "NTT Information Web Station," available at <http://www.ntt-east.co.jp/info-st/network/traffic/index.html> (in Japanese).
- [12] "AVICI Systems," available at <http://www.avici.com>.